

## GONDOLA ENDS INSTRUCTIONS

PLEASE KEEP INSTRUCTIONS FOR FUTURE USE / REFERENCE

### IMPORTANT

- Read the instructions before assembling the product.
- No tools are required for this assembling.
- Each piece is marked with a number.
- If possible, ask someone to help you. One person should be enough.
- If this item becomes unstable, do not continue to use.
- Do not store in direct sunlight.
- Keep away from heat sources such as open fires or similar hazards.
- KEEP AWAY FROM FIRE.
- Natural product; store in a cool dry environment.
- Do not use aggressive chemicals to clean.
- Use a soft cloth to clean the product.
- This product is made from natural materials, please be mindful of any sharp edges.
- Do not move the product when loaded. Unload it completely to be moved.
- Boxes are heavy. Make sure they don't fall over, otherwise the product can be damaged.



### PRODUCT INFO

Size spec: 1900 high x 1200 wide x 460 depth (mm)  
 Weight: 30 kg  
 Weight capacity of the product stated: 180 kg (360 bottles)

### CONTENTS

- Pieces 12 , 13

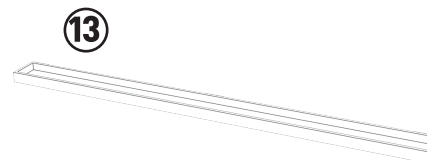
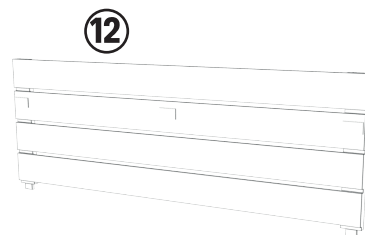

### MODEL BASIC

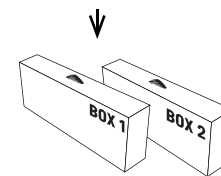
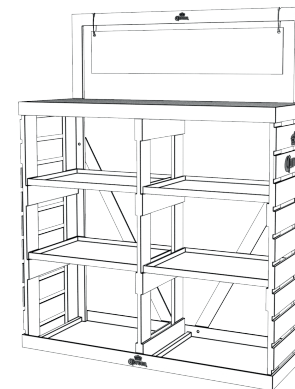

### MODEL BASIC + EXTRAS

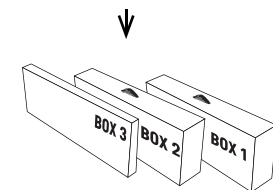
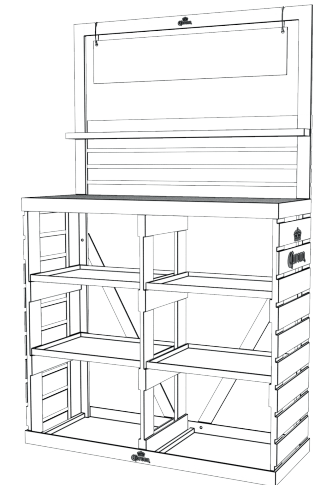

IF YOU HAVE ANY DOUBTS, SCAN THE QR CODE TO FIND VIDEOS AND PHOTOS





GONDOLA ENDS

PLEASE KEEP THE BOX FOR FUTURE USE / REFERENCE

# ASSEMBLY INSTRUCTIONS

IF YOU HAVE ANY DOUBTS, SCAN THE QR CODE TO FIND VIDEOS AND PHOTOS



BOX 1 + BOX 2 + BOX 3

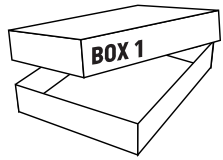

OPEN BOX 1 AND TAKE ALL THE PIECES OUT

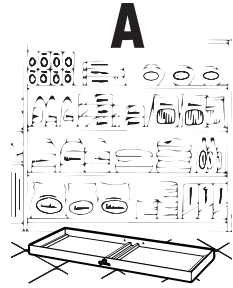

PLACE PIECE 1 WHERE YOU WANT THE FURNITURE TO BE PLACED

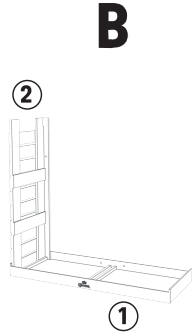

FIT 2 INSIDE 1

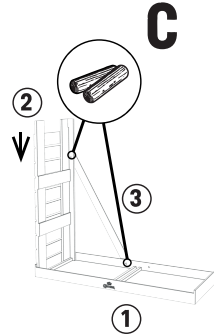

USE THE DOWELS TO FIT 3 TO 1 AND 2

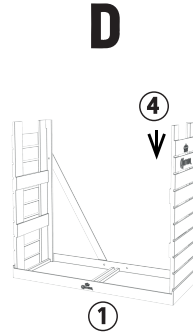

FIT 4 INSIDE 1

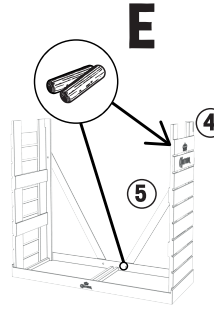

USE THE DOWELS TO FIT 5 TO 1 AND 4

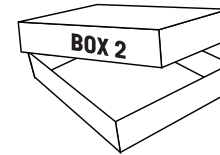

OPEN BOX 2

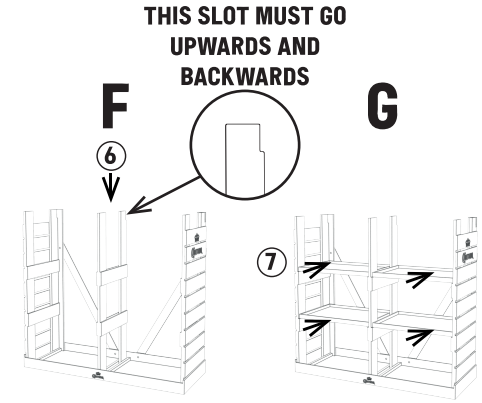

SET 6 IN THE MIDDLE OF 1

THIS SLOT MUST GO UPWARDS AND BACKWARDS

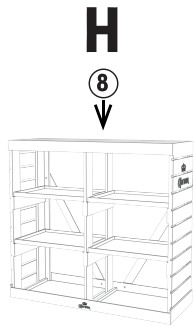

SET 8 ON THE TOP MAKE SURE THAT PIECES 2, 4 & 6 FIT CORRECTLY



OPEN BOX 3



FIT 12

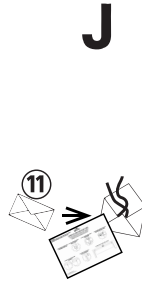

TAKE THE ENVELOPE AND FOLIO THE INSTRUCTIONS

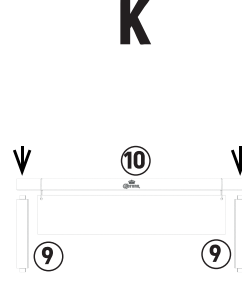

10

9

9

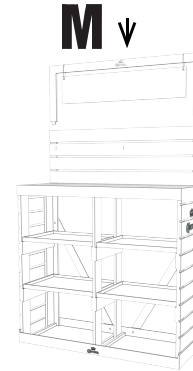

M

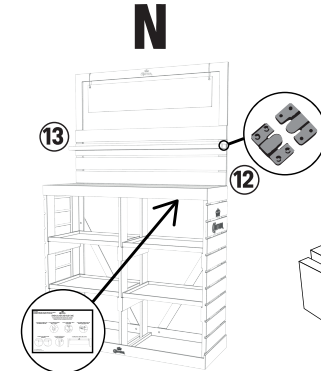

HOOK 13 ON 12 SAVE THE INSTRUCTIONS IN THE ENVELOPE

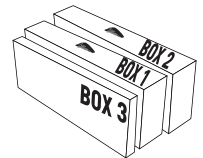

KEEP THE BOXES IN A SAFE PLACE FOR FURTHER TRANSPORT

# DISASSEMBLY INSTRUCTIONS

IF YOU HAVE ANY DOUBTS, SCAN THE QR CODE TO FIND VIDEOS AND PHOTOS



BOX 1 + BOX 2 + BOX 3

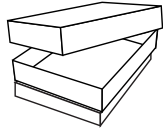

TAKE THE BOXES WHERE YOU STORED THEM

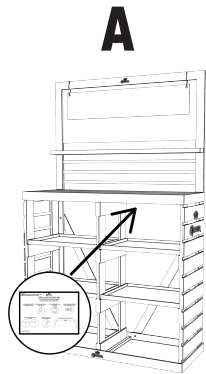

TAKE THE INSTRUCTIONS FROM THE ENVELOPE BELOW 8



UNHOOK 13



TAKE OUT 9 & 10 AND KEEP THEM APART



STORE 13 & 12 INSIDE BOX 3

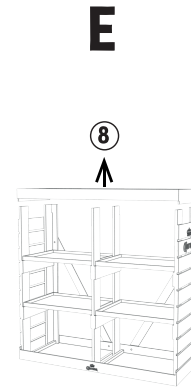

PULL UP 8 AND PLACE IT INSIDE BOX 2

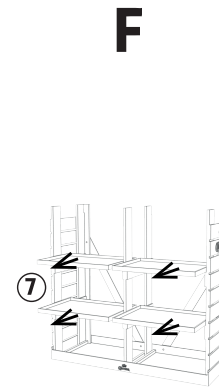
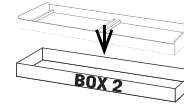

STORE PIECES 7 INSIDE BOX 2

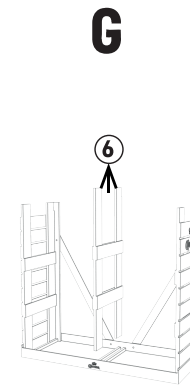
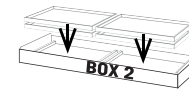

PULL UP 6

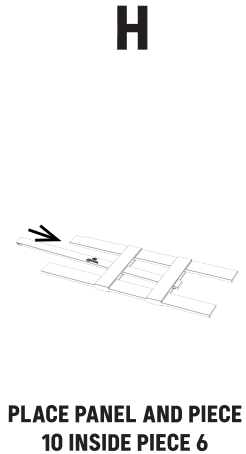

PLACE PANEL AND PIECE 10 INSIDE PIECE 6

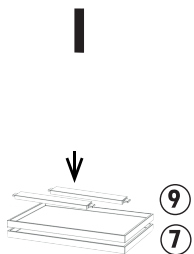

STORE PIECES 9 INSIDE PIECES 7

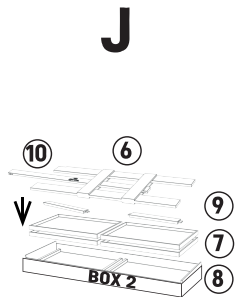

STORE PIECES 6, 7, 8, 9, 10 IN BOX 2 (SEE PICTURE)

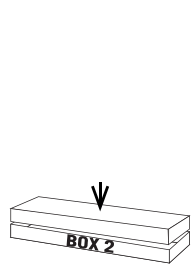

CLOSE BOX 2 SEALED IT PROPERLY

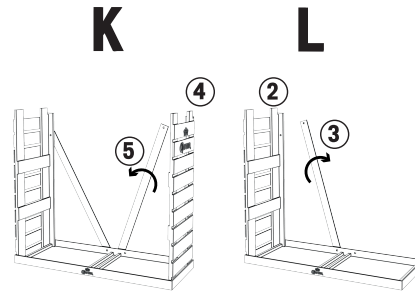

PUT THE PIECES 5, 4, 3, 2 ASIDE

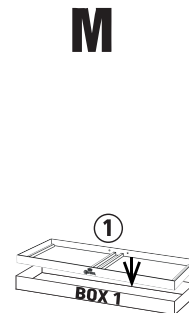

STORE PIECE 1 INSIDE BOX 1

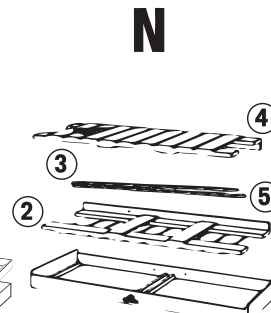

STORE PIECES 2, 3, 4, 5 IN BOX 1 (SEE PICTURE)

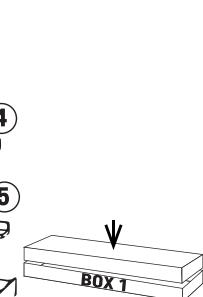

CLOSE BOX 1 SEALED IT PROPERLY

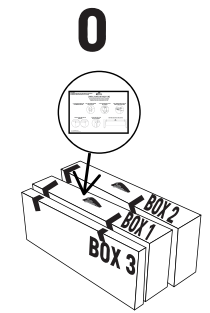

MAKE SURE THE INSTRUCTIONS ARE INSIDE MAKE SURE BOTH BOXES ARE PROPERLY CLOSED AND SEALED

HANDLE WITH CARE. PRODUCT CAN BE DAMAGED IF THE BOX IS DROPPED